

technowood

TECHNOWOOD
INTERIOR & EXTERIOR
CLADDING

Natural Wood Veneered
ESD-10 Siding Systems

98%

Less Tree Use



A2
Fireproof



No Bend
& Crack



Custom Design
Solutions



Delamination
Warranty



Recyclable



Various
Veneer & Varnish
Options



Low
Maintenance
Costs



Up to 7,5 mt in
one piece



1

3D PERSPECTIVE VIEW
SYSTEM COMPONENTS
CLADDING OPTIONS



5

CORNER DETAILS
PARAPET DETAILS
DOOR & WINDOW FRAME
CONNECTION DETAILS
SOFFIT DETAILS
INSTALLATION PROCESS



10

MATERIAL SPECIFICATIONS
REACTION TO FIRE
CHEMICAL & BIOLOGICAL SPECS

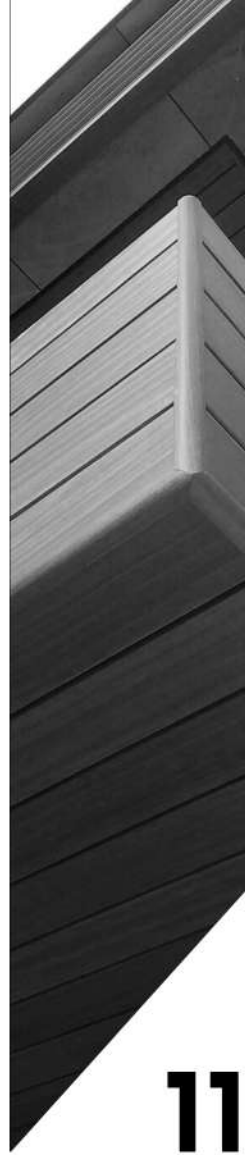

11

CLEANING & CARE
INSTRUCTIONS



12

UNLOADING MANUALS
STACKING & STORAGE
INSTRUCTIONS

CONTENTS

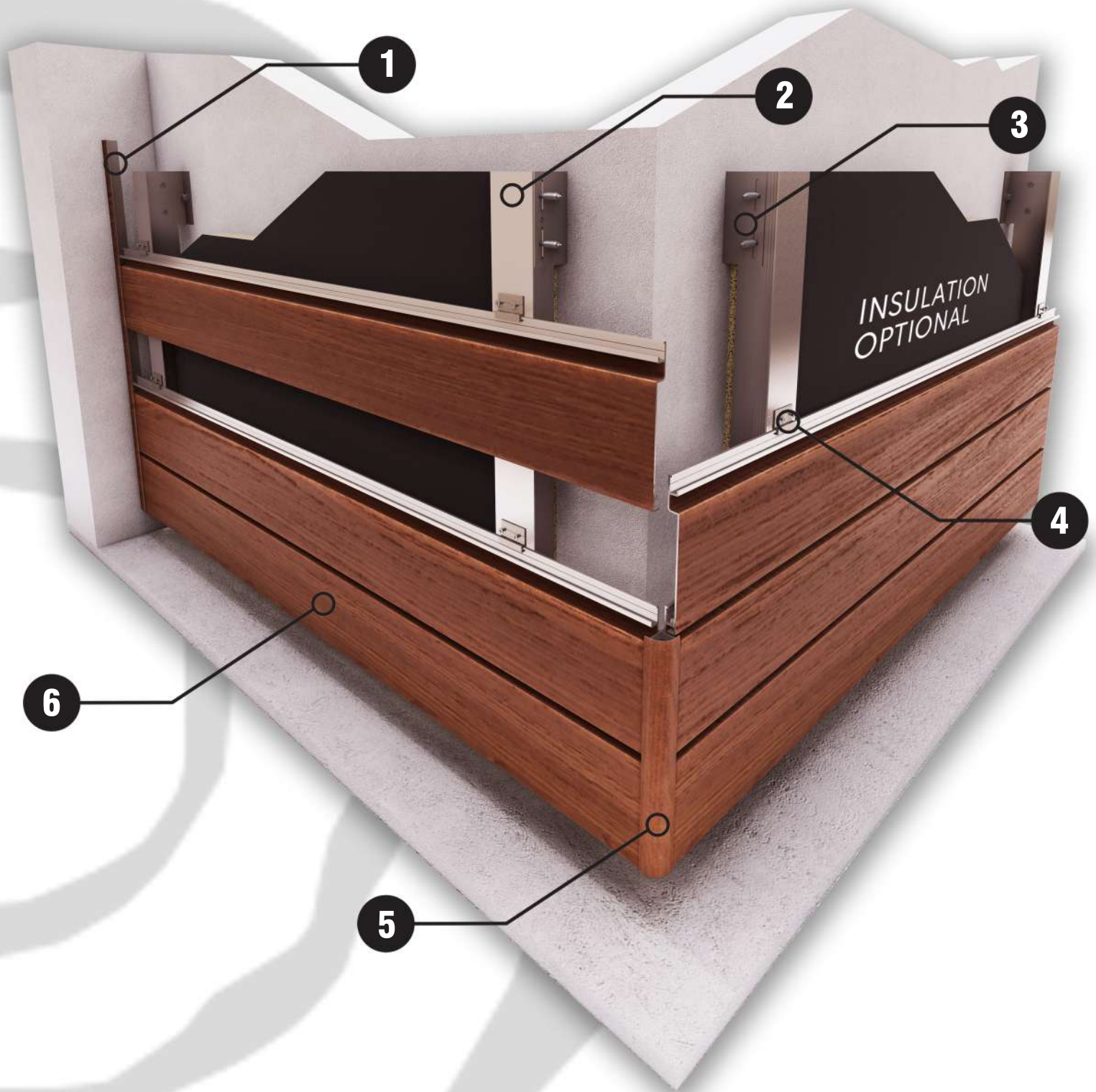

1 FINISHING PROFILE

2 ALUMINUM T PROFILE

3 L BRACKET







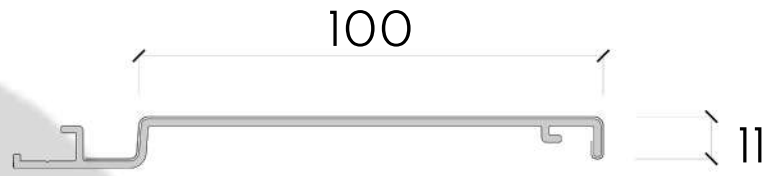

4 HIDDEN FASTENER CLIP







5 CORNER PROFILE

6 TECHNOWOOD ESD-10
ALUMINUM SIDING



Product Code	Siding	Size [mm]
ESD-10		100 x 11

Product Code	Corner Profiles	Section View	Size [mm]
ECL-3030			30 x 30
ECW-1515			15 x 15
ECF-3520			35 x 20
ECX-3419			34,9 x 19,9

Product Name	Accessories	Section View	Size [mm]
L BRACKET			VARIES
T PROFILE			VARIES
FASTENER CLIP			30 x 20
SCREWS			30 x 20

- 1 PVC CONNECTION WEDGE
- 2 FIXED SCREWS ON THE EXPANSION HOLES
- 3 ALUMINUM T PROFILE
- 4 PAN HEAD SELF DRILLING SCREW
- 5 INSULATION (OPTIONAL)
- 6 SIDING FASTENER CLIP
- 7 TECHNWOOD ESD-10 ALU-SIDING
- 8 GALVANIZED STEEL L BRACKET
- 9 FIXED SCREW ON THE STABILIZING HOLE
- 10 TECHNWOOD ECL-3030 ALU-CORNER PROFILE

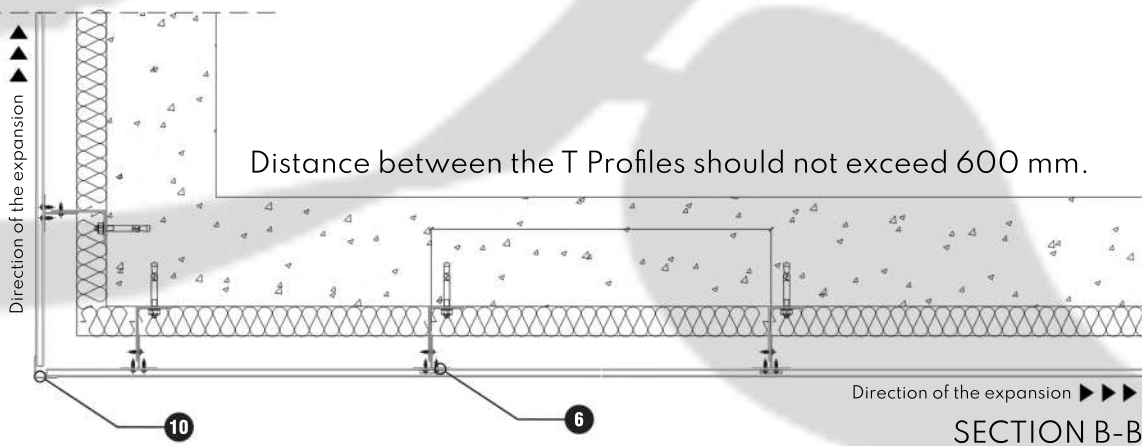
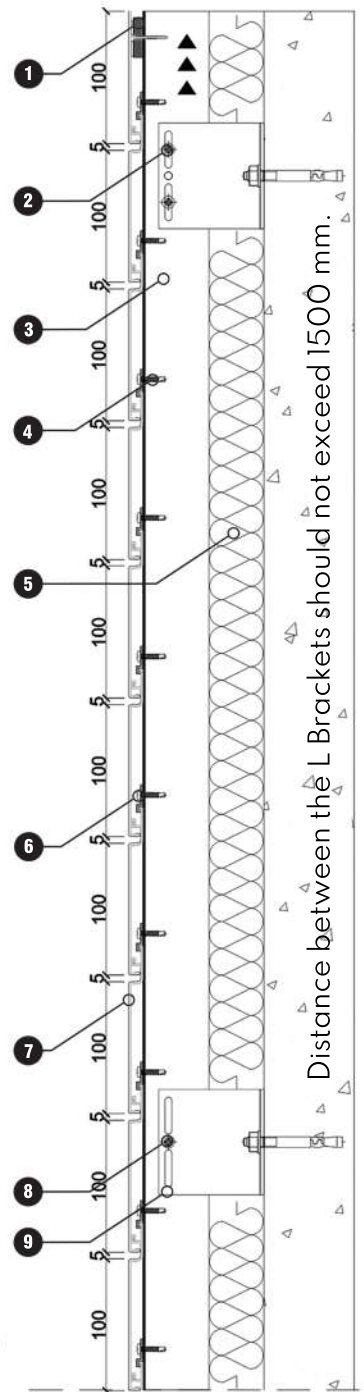
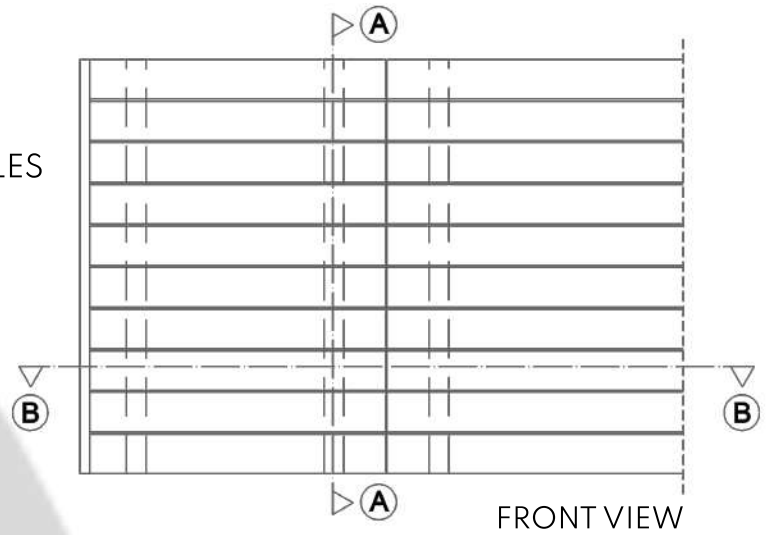

SECTION A-A

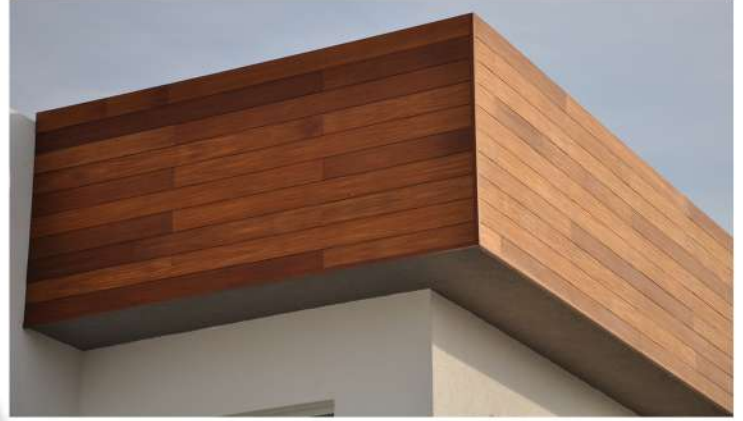
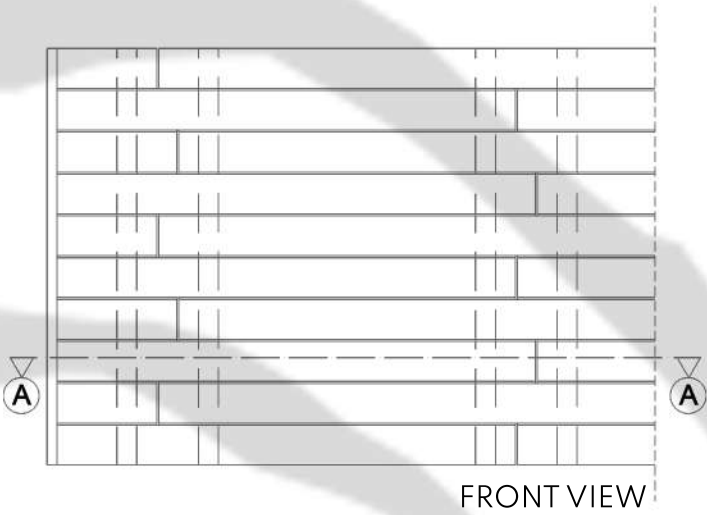

- 1 TECHNWOOD ECL-3030 ALU-CORNER
- 2 SIDING FASTENER CLIP
- 3 PAN HEAD SELF DRILLING SCREW
- 4 INSULATION (OPTIONAL)
- 5 TECHNWOOD ESD-10 ALU-SIDING
- 6 ALUMINUM T PROFILE
- 7 GALVANIZED STEEL L BRACKET

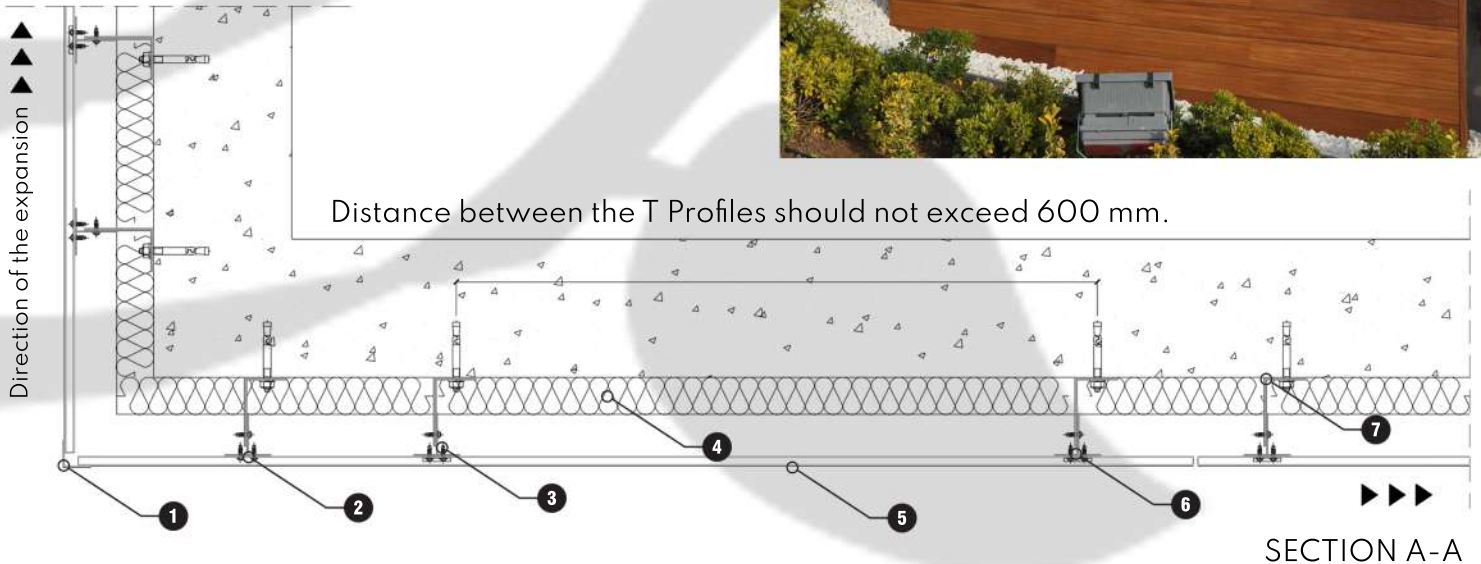

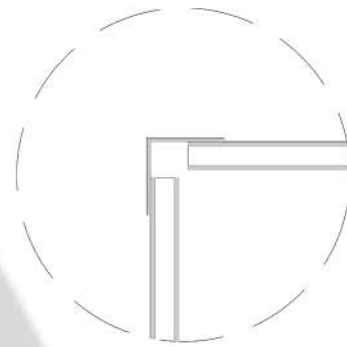
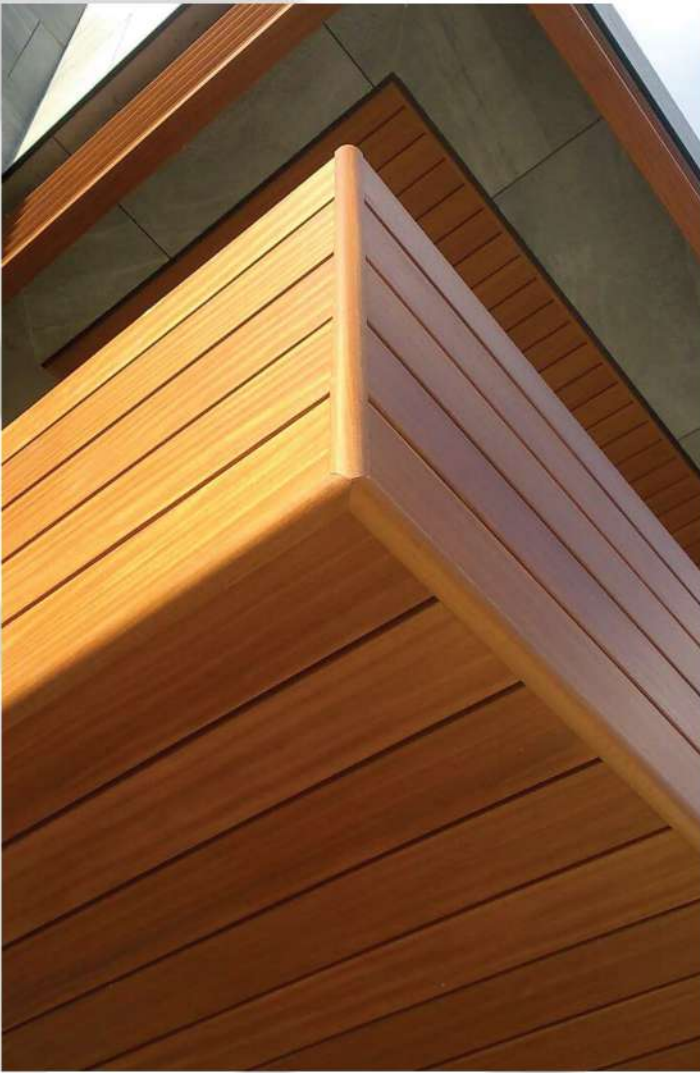

ECL-3030
CORNER PROFILE

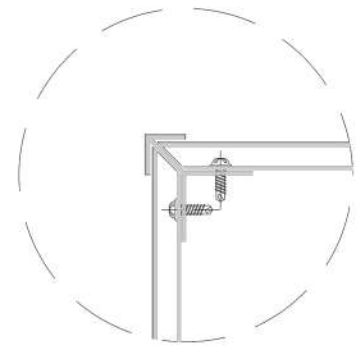

ECW-1515
CORNER PROFILE

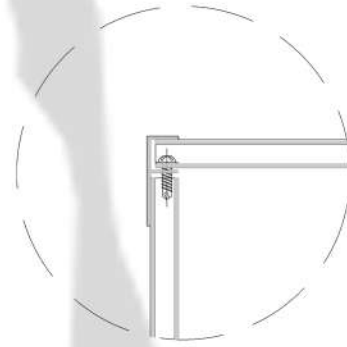

ECF-3520
CORNER PROFILE

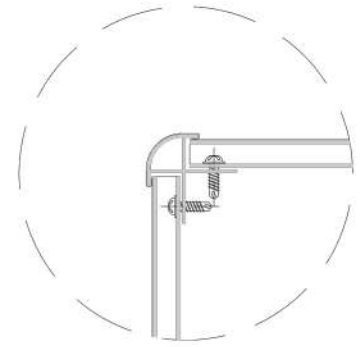

ECX-3419
CORNER PROFILE

- 1** TECHNWOOD ECX-3419 ALU-CORNER
- 2** PAN HEAD SELF DRILLING SCREW
- 3** SIDING FASTENER CLIP
- 4** INSULATION (OPTIONAL)
- 5** ALUMINUM T PROFILE
- 6** GALVANIZED STEEL L BRACKET
- 7** TECHNWOOD ESD-10 ALU-SIDING

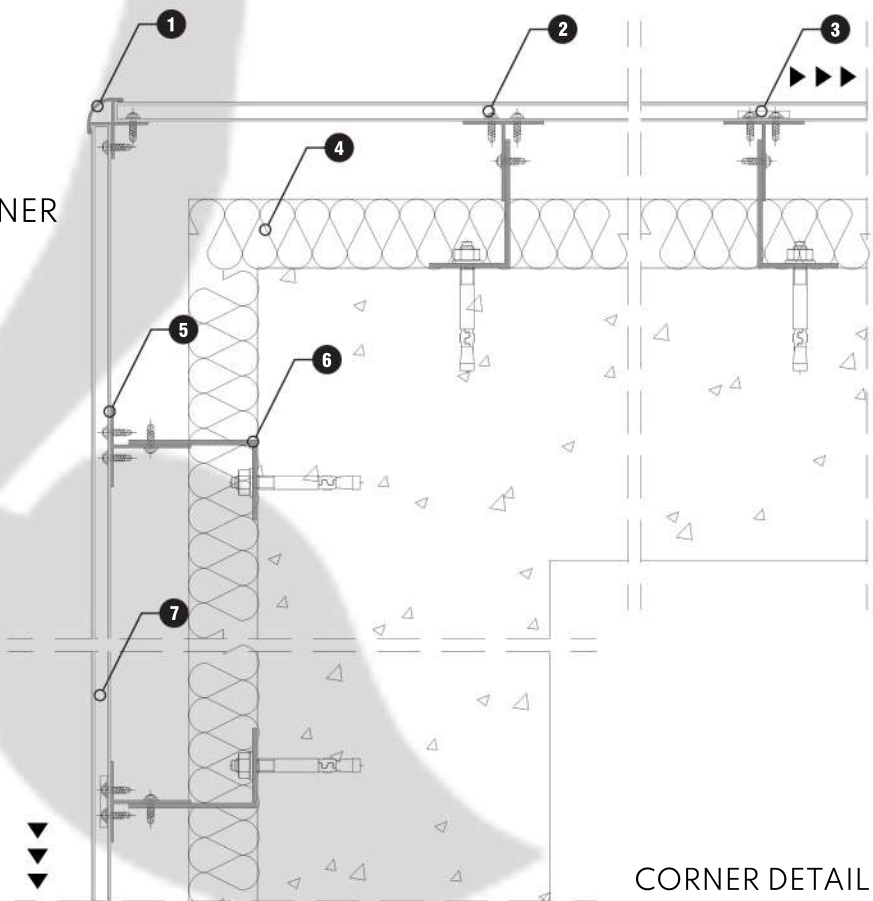

CORNER DETAIL

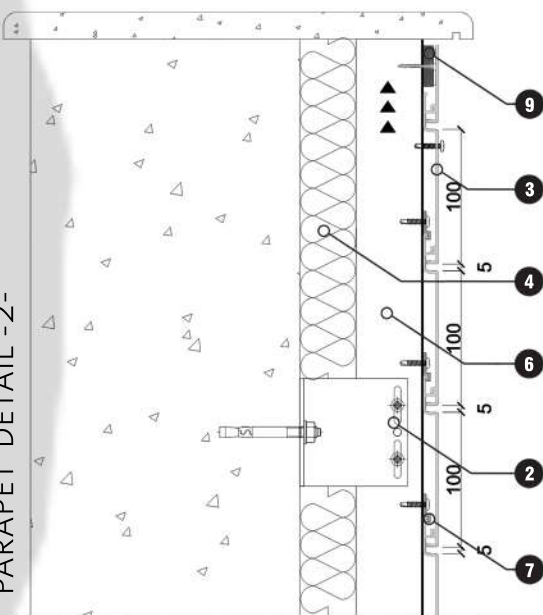

PARAPET DETAIL -2-

- 1** ALUMINUM PARAPET COATING
- 2** GALVANIZED STEEL L BRACKET
- 3** TECHNOWOOD ESD-10 ALU-SIDING
- 4** INSULATION (OPTIONAL)
- 5** PAN HEAD SELF DRILLING SCREW
- 6** ALUMINUM T PROFILE
- 7** SIDING FASTENER CLIP
- 8** ESD-10 ALU-SIDING STARTING PART
- 9** POLYURETHANE CONNECTION WEDGE

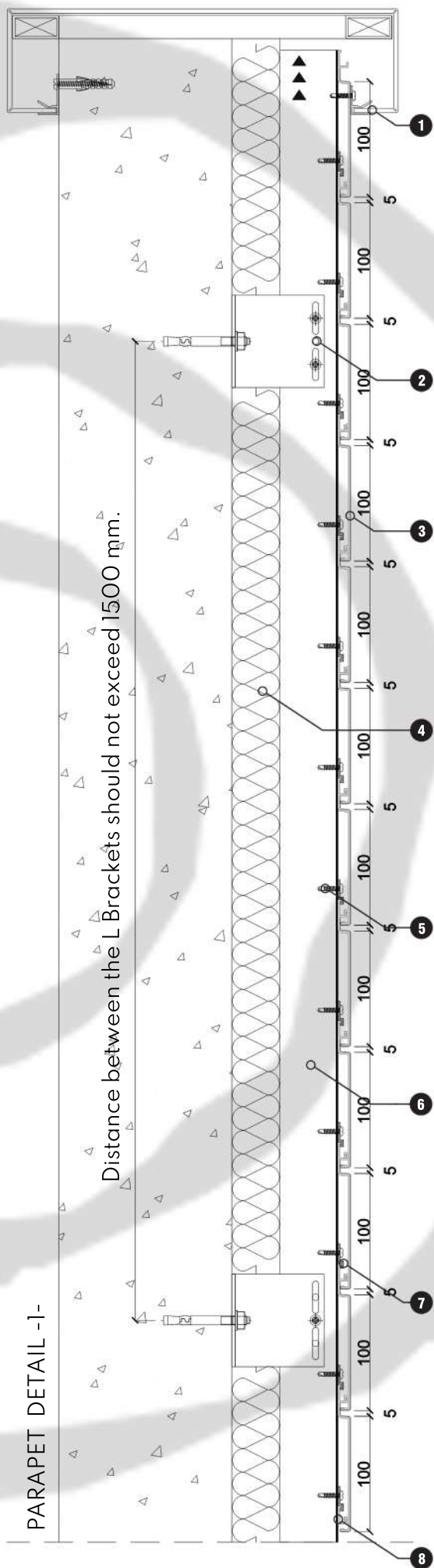

PARAPET DETAIL -1-

- 1 WINDOW & DOOR FRAME
- 2 TECHNOWOOD ECF-3520 CORNER
- 3 INSULATION (OPTIONAL)
- 4 PAN HEAD SELF DRILLING SCREW
- 5 ALUMINUM T PROFILE
- 6 GALVANIZED STEEL L BRACKET
- 7 TECHNOWOOD ESD-10 ALU-SIDING

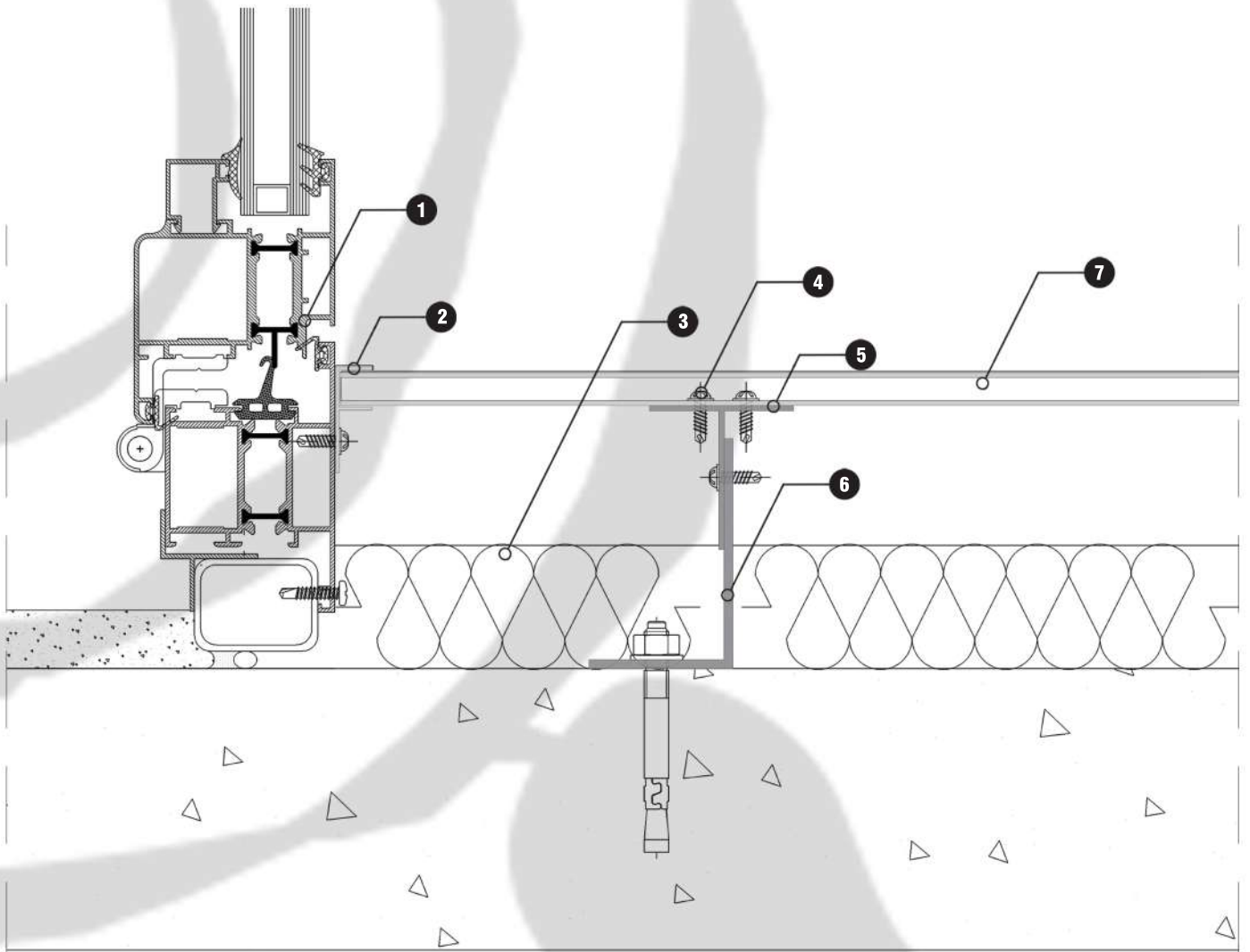

WINDOW & DOOR CONNECTION DETAIL -1-

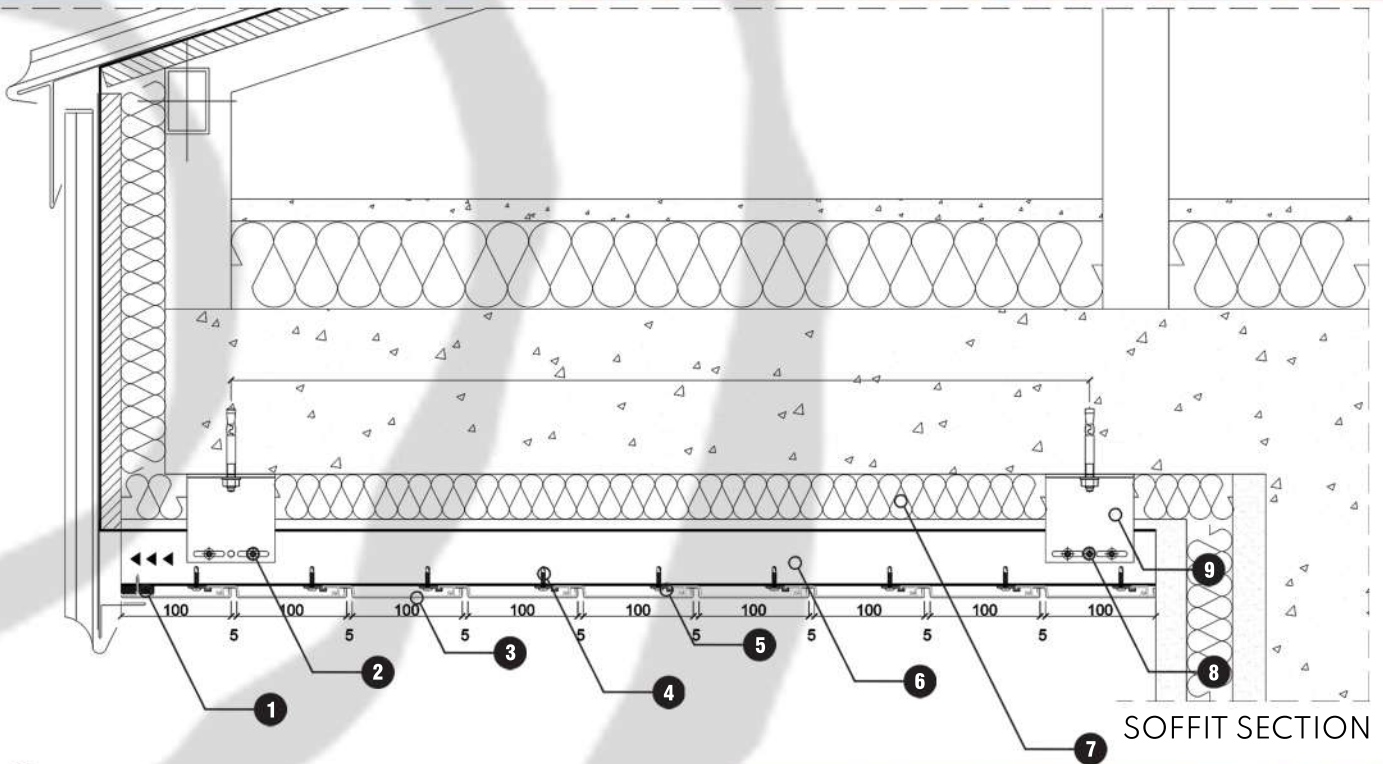

- 1** POLYURETHANE CONNECTION WEDGE
- 2** FIXED SCREWS ON THE EXPANSION HOLES
- 3** TECHNOWOOD ESD-10 ALU-SIDING
- 4** PAN HEAD SELF DRILLING SCREW
- 5** SIDING FASTENER CLIP
- 6** ALUMINUM T PROFILE
- 7** INSULATION (OPTIONAL)
- 8** FIXED SCREW ON THE STABLIZING HOLE
- 9** GALVANIZED STEEL L BRACKET





1 Align and install L brackets with minimum; 600mm horizontal axis 1500mm vertical axis.



2 Connect T profiles to the L brackets with screws (Consider the direction of expansion).

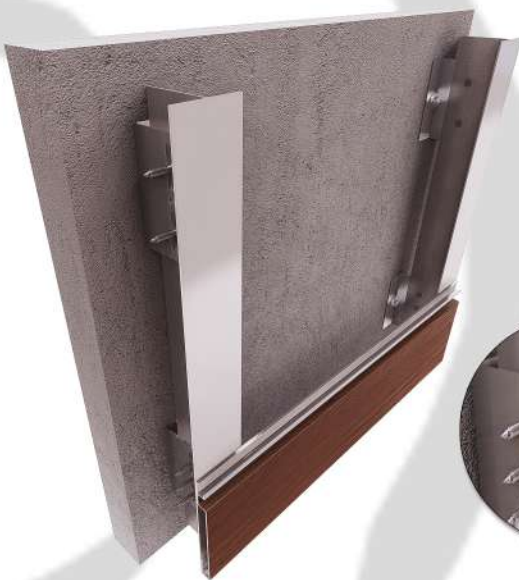

3 Screw starting trim on T profiles and start to assemble the first ESD-10.



4 To control the expansion, insert fastener clips on top of the first ESD-10, later on screw the fastener clips on the T profiles.



5 Mount the next ESD-10 on top of the first one.



6 Repeat 4th and 5th processes as described till the cladding is completed.

ALUMINUM MATERIAL SPECIFICATIONS

COEFFICIENTS	VALUE	UNIT
Specific Weight	2.71	GR / CM ³
Expansion Factor	23,4 x 0,000001	1 / C
Elasticity Module	6900	KG / MM ²
Pulling Strength	17.5	24 C DE KG / MM ²
Elongation	%08	24 C DE KG / MM ²
Hardness	60-65	BRINELL(HB) KG / MM ²
Yield Strength	14	KG / MM ²
Shear Strength	13	KG / MM ²
Aluminium Alloy	AlMgSi0,5 6063 60	DIN - GERMANY BS - ENGLAND ETIAL - TURKEY











REACTION TO FIRE

Reaction to Fire	EN 13501-1:2007+A1:2009	A2 Class
Smoke Production	EN 13501-1:2007+A1:2009	S1
Flaming Droplets/Particles	EN 13501-1:2007+A1:2009	d0
Limited-combustibility	NFPA 259	Passed
Surface Burning Characteristics	UL 723 / NFPA 255 / ASTM E84	Class A
Flammability	GOST 30244-94	Non-combustible
Fire Hazard Properties	AS5637.1:2015	Group 1 Rating
Spread of Flame	AS/NZ 1530.3-1999	Index - 0

CHEMICAL AND BIOLOGICAL FEATURES

Formaldehyde emission	EN 717-2:1994	0,1 mg HCHO/(m ² h)
Heavy metal content (Pb, Ge, Cr, Hg)	GB18584 - 2001 GB18580 - 2001	< 0,5 ppm
Evaluation of the action of microorganisms (scale from 0 to 5)	EN ISO 846:97	Test result: 1

CLEANING AND CARE INSTRUCTIONS

1. For cleaning, a soft and damp cloth can be used. No cleaning liquid should be used in temperatures over 40°C. This can cause permanent plaque deposits to form over the paint. 
2. Products that are exposed to sunlight can fade away in time. In order to prevent this, it is recommended to renew the varnishing at least every 3-4 years, with water based varnish. This duration might be longer or shorter, depending on the duration of exposure to sunlight of the products. 
3. Before varnish treatment, it is essential that the surface is deprived from all kinds of foreign materials, oils, old paint residue, silicon and dust. A foam/sponge or 220 grit sandpaper can be used to do this. 
4. With the help of a roller or brush, 2 or 3 coats of varnish is applied to the surface that is free of dust. The instructions given by the varnish producer should be complied with. 
5. Ideal application temperature is between 15°C and 30°C. It is not recommended to be applied to be applied in temperatures below 10°C. 
6. The relative humidity during the application should be below 80%. For maintenance, spring or summer months should be preferred. 
7. Keep the varnish that is used for maintenance away from children. Avoid eye or skin contact. In case of contact with eyes, rinse immediately with plenty of water and consult to a physician. 
8. The disposal and/or recycling of the varnish/packaging of the applied varnish should be made in accordance with the legislations in power, preferable by a recognized collector or a certified company. 
9. If it is necessary to use a scaffolding or ladder for varnishing, necessary safety measures must be taken. 
10. The surface should not be cleaned with cleaning materials that contain alcohol and ammonia. 



UNLOADING FROM THE VEHICLE

Necessary and appropriate tools should be used for the unloading of the materials that arrived at the workplace, and taking them to the storage area or directly to the installation area. Especially for the panels and profiles that are longer than 6 meter, by using necessary tools in proper settings, the risk of the materials being damaged during the process is minimized. If the length of the materials is between 6 to 8 meters, a forklift with wide arms should be used (3.5m), if the materials are below 6 meter, a forklift with narrow arms should be used (1.2 m). When the unloading is done with a forklift, one must be careful that the overflowing ends of the materials from the forklift should not exceed 2 to 2,5 meters.

1. Ropes that will be used should be nylon, hemp or silk, and should not be steel rope or chain.
2. In order for the ropes not to crush the corners of the materials, wooden chocks should be placed at the bottom and the top side of the stack, to where the ropes are. These chocks should exceed the panels at least 3 to 5 cm.



STACKING MANUAL

If the materials are taken from the stack at the site manually, to prevent the natural wooden coatings and panels from being scratched, the following issues should be considered.

1. Materials should not be pulled by grabbing from one end.
2. The materials when being carried to the site, should not be pulled or slid over the purlins.
3. When the materials are taken away from the stack or carried, if they are short ones (3-5 meters), they should be grabbed from both ends, if they are long materials (6 meters), they should be grabbed from both ends and in the middle also, keeping a balance.
4. While carrying the material, make sure that you do not step on another piece of material

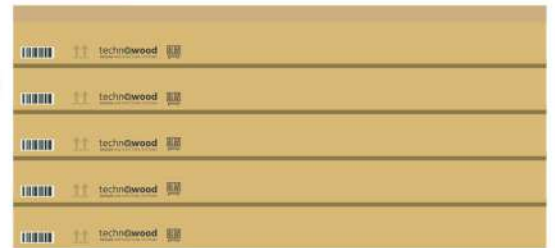

STORAGE INSTRUCTIONS

Regardless of the duration of storage, while doing stacking, the following issues and measures should be taken into account:

1. Materials should be stacked over one another, no more than 1 meters in length.
2. Chock height should be 10 cm, and the distance between chocks should be at least 1.5 meters.
3. If there is a wooden pallet beneath the package, and if there are some materials protruding from the palette, they should be supported with wooden chocks, the same height as the palette itself.
4. The chocks in between the packages should be placed one on top of another, aligned in the same line.
5. Polyurethane or wooden chocks should be used only.
6. Never step on or walk over the stack or the panels that lie on the ground.
7. If the materials will be stored for a long time, their packages should be left open in order to prevent the dampening of the products.
8. The stacks should absolutely be kept in a covered warehouse, away from rain or humidity.





Alaz

techno@wood